

DALI 2 LED Drivers (With System Feedback)

Constant Current Version - DALI/1-10V/Switch-Dim



HED6010 / HED6020 / HED6045
HED6045L / HED6060 / HED6060L



Applications

Use with 'plug n' play' or DALI broadcast master.
Fully addressable DALI systems, including fault feedback.
Switch-Dim
1-10V Dimming Systems
Models for all fixture types- insulated terminal cover with cord restraint:

- Office / Commercial Lighting
- Health Care
- Classrooms

Use for retrofit upgrades & new luminaire designs.



Features

- DALI 2, with DALI feedback
 - 1-10V
 - Switch-Dim with Synchronization
 - Stand-by Power < 0.5W
 - Active PFC Design
 - Analogue Flicker-free Dimming
 - Logarithmic Dimming
 - Linear Dimming
 - Configurable Constant Current (CC) Output via Dip-Switch
 - Thermal Cut-out Protection
 - Short Circuit Protection
 - Over-load Protection
 - Permanent Settings Memory, Protected against Loss of Power
 - 5 Year, 50,000hr Warranty
- } All with Auto-restart

Output Configuration

HED6010, 1x10W

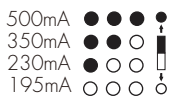

HED6020, 1x20W

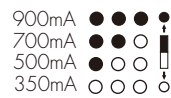

HED6045, 1x45W

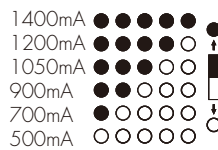

HED6045L, 1x45W

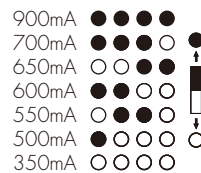

HED6060, 1x60W

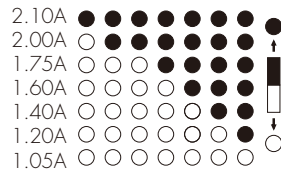

HED6060L, 1x60W

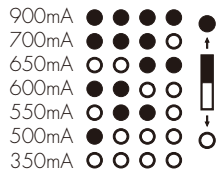

Warning: Please make sure the correct current is selected before starting the driver!

Technical Data

	Model No.	HED6010	HED6020	HED6045	HED6045L	HED6060	HED6060L
Input	Mains Voltage	220~240VAC 50/60Hz					
	Mains Current	0.075~0.065A	0.125~0.115A	0.22~0.2A	0.22~0.2A	0.35~0.27A	0.35~0.27A
	Power Factor	0.9	0.93	0.95	0.95	0.95	0.95
	Max. Efficiency	88%					
	Dielectric Strength	Input→Output : 3000VAC					
	Leakage Current	<0.25mA	<0.25mA	<0.25mA	<0.25mA	<0.25mA	<0.25mA
Output	Ripple Current	<3%	<3%	<3%	<3%	<3%	<3%
	Uout Max.	52V	60V	75V	95V	80V	115V
	Turn-on Time	<0.5s	<0.5s	<0.5s	<0.5s	<0.5s	<0.5s
	Dimming Interface	DALI, Switch-Dim, 1-10V					
Environment	Operation Temp.	-20~+50°C	-20~+45°C	-20~+45°C	-20~+45°C	-20~+45°C	-20~+45°C
	Case Temp. (Max.)	75°C	75°C	85°C	85°C	80°C	80°C
	IP Rating	IP20	IP20	IP20	IP20	IP20	IP20
Safety and EMC	EMC Standard	EN55015, EN61547, EN61000-3-2, EN61000-3-3					
	Safety Standard	EN61347-1, EN62493, EN61347-2-13					
	DALI Standard	IEC62386-101 ; IEC62386-102 ; IEC62386-207					
	Certifications	Semko, CB, SAA, CE , EMC					

Model No.	Max. output power/current/voltage range			
HED6010	8W/ 195mA /6~41V	9.5W/ 230mA /6~41V	12.5W/ 350mA /6~36V	12.5W/ 500mA /6~25V
HED6020	15.5W/ 350mA /10~45V	21.5W/ 500mA /10~43V	21W/ 700mA /10~30V	20.5W/ 900mA /10~23V
HED6045	28W/ 500mA /10~56V	40W/ 700mA /10~56V	45W/ 900mA /10~50V	45W/ 1050mA /10~42V
	40W/1200mA /10~34V	40W/ 1400mA /10~28V		
HED6045L	26W/350mA /15~75V	37W/ 500mA /15~75V	41W/ 550mA /15~75V	45W/ 600mA /15~75V
	45W/650mA /15~75V	45W/ 700mA /15~65V	45W/ 900mA /15~50V	
HED6060	55W/1.05A /15~53V	60W/ 1.2A /15~50V	60W/ 1.4A /15~43V	60W/ 1.6A /15~38V
	60W/ 1.75A /15~35V	60W/ 2.0A /15~30V	60W/ 2.1A /15~28V	
HED6060L	31W/350mA /15~90V	45W/ 500mA /15~90V	50W/ 550mA /15~90V	54W/ 600mA /15~90V
	58W/650mA /15~90V	60W/ 700mA /15~86V	60W/ 900mA /15~67V	

Dimensions and Terminals

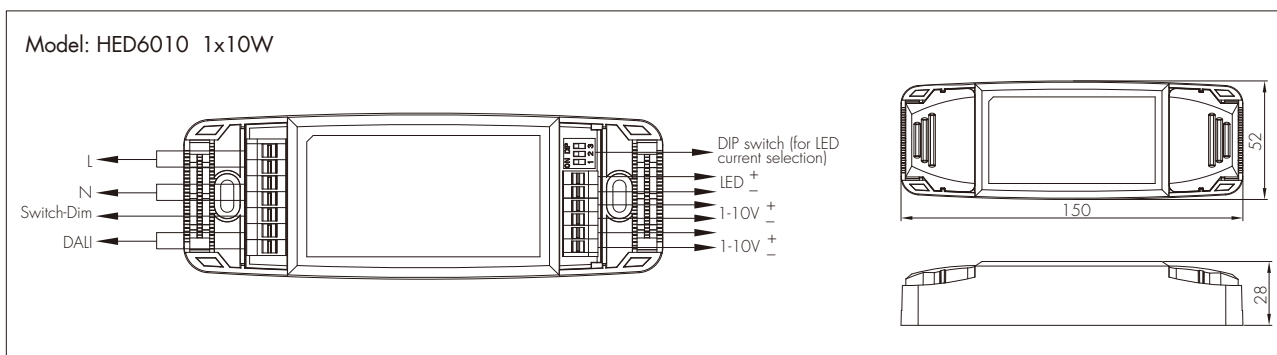

Model: HED6020 1x20W

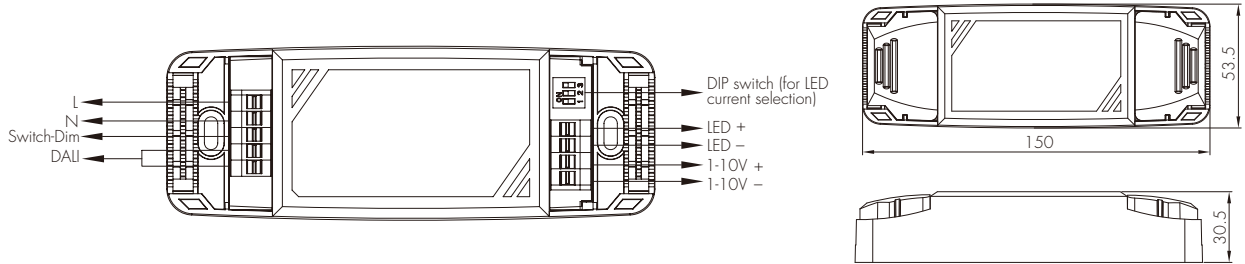

Model: HED6045 1x45W

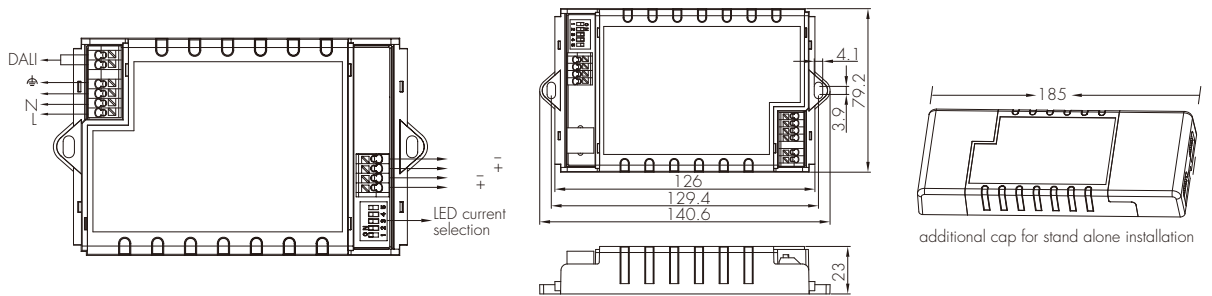

Model: HED6045L 1x45W (low current version for HED6045)

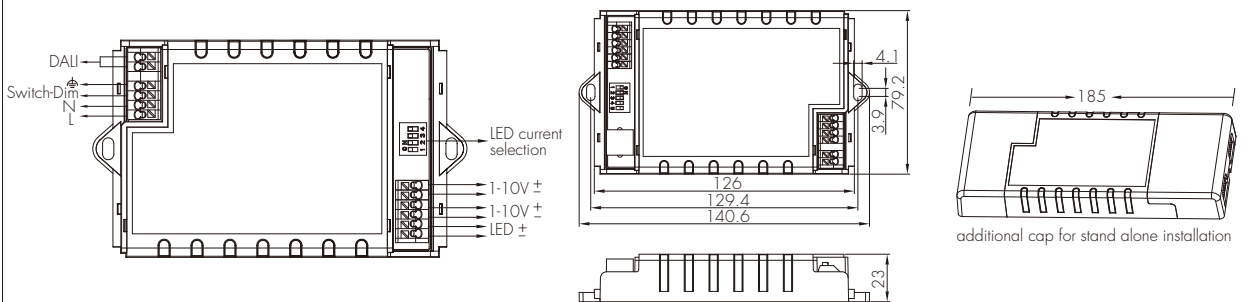

Model: HED6060 1x60W

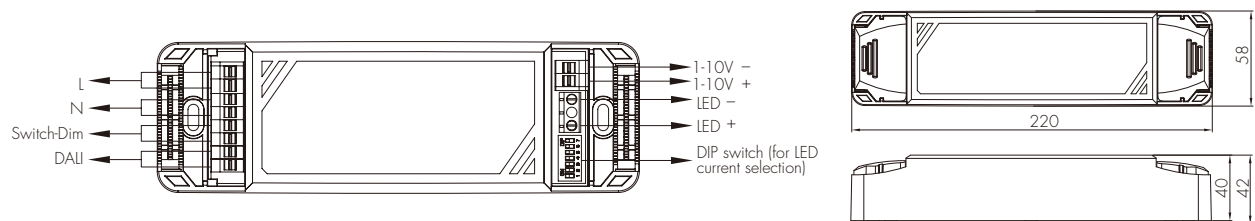

Model: HED6060L 1x60W (low current version for HED6060)

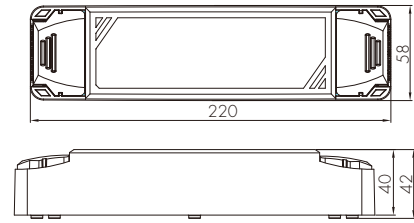
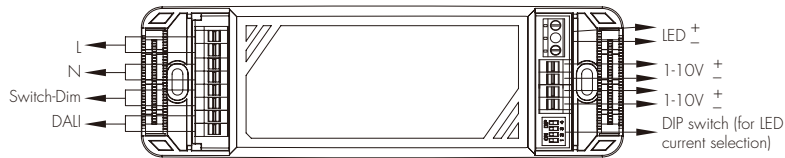

Wire Preparation

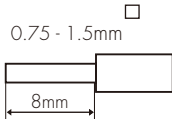
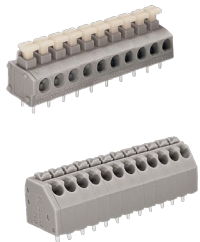

Model
HED6010
HED6020
HED6045
HED6045L

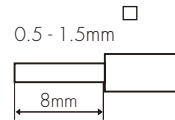
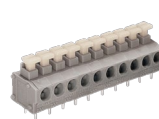

Terminals Model
L, N HED6060
DALI HED6060L
Switch-Dim

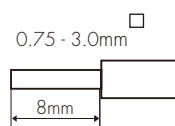

1-10V HED6060
LED output HED6060L

To make or release the wire from the terminal, use a screwdriver to push down the button.

Loading and In-rush Current

Model	HED6010	HED6020	HED6045	HED6045L	HED6060	HED6060L
In-rush Current (I _{max.})	1.2A	5.3A	13.2A	13A	4.05A	4.65A
Pulse Time	60µs	100 µs	140 µs	130 µs	60 µs	60 µs

Number of Drivers Based upon 16A Circuit Breaker

Cct Breaker Type	HED6010	HED6020	HED6045	HED6045L	HED6060	HED6060L
Type B	105	65	30	30	30	27
Type C	210	108	150	50	50	45

Wiring Diagrams

DALI Connections

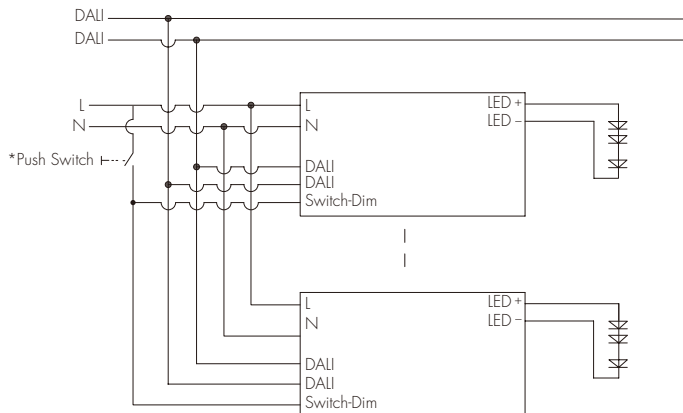

- * Optional Switch-Dim for manual over-ride of DALI
1-10V is disabled upon DALI connection
- * Unused terminals have been omitted for clarity.

Switch-Dim Connections

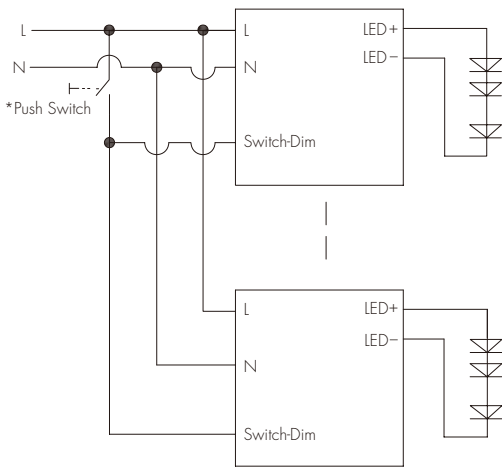

* Unused terminals have been omitted for clarity.

1-10V Connections

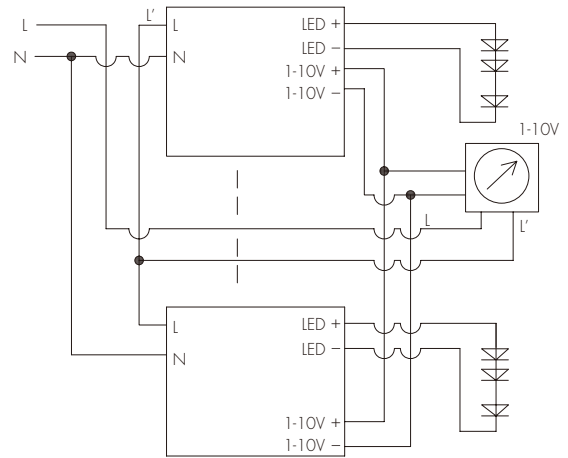

* Unused terminals have been omitted for clarity.

Performance Characteristics

HED6010

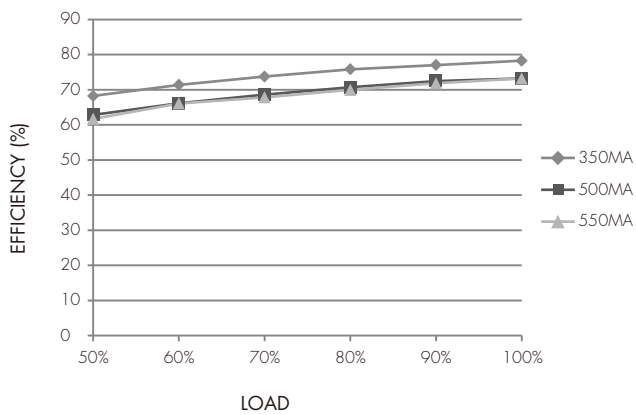

* Typical Efficiency vs Load

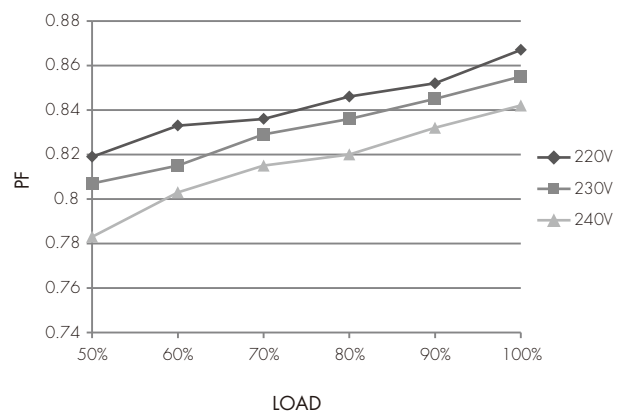

* Typical Power Factor vs Load

HED6020

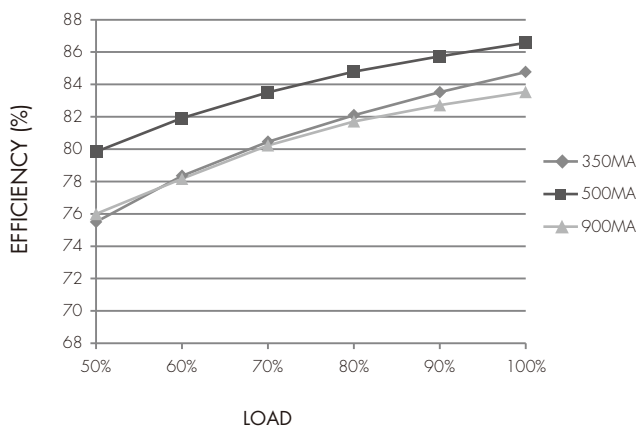

* Typical Efficiency vs Load

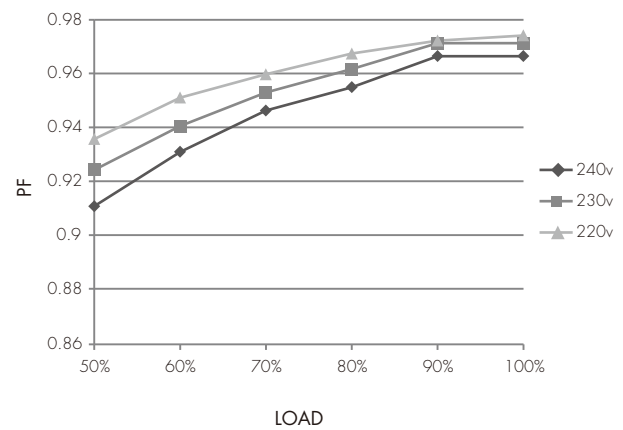

* Typical Power Factor vs Load

HED6045

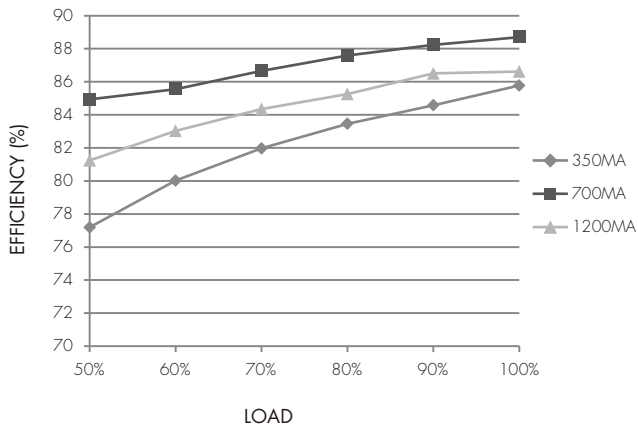

* Typical Efficiency vs Load

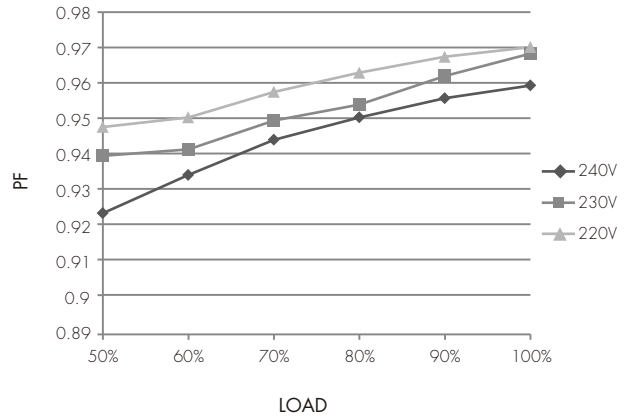

* Typical Power Factor vs Load

HED6045L

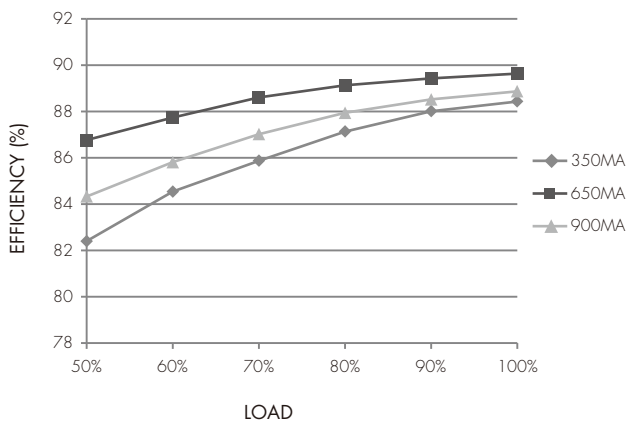

* Typical Efficiency vs Load

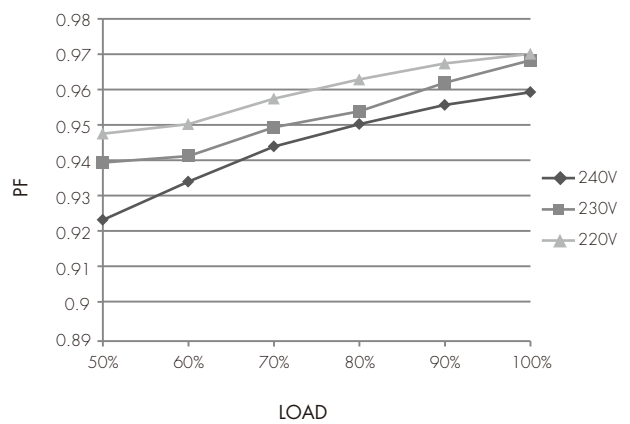

* Typical Power Factor vs Load

HED6060

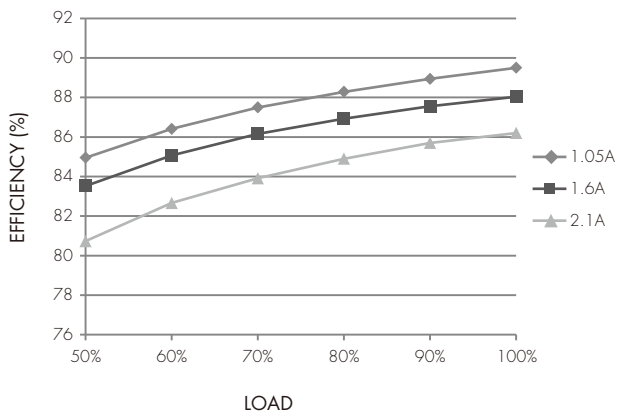

* Typical Efficiency vs Load

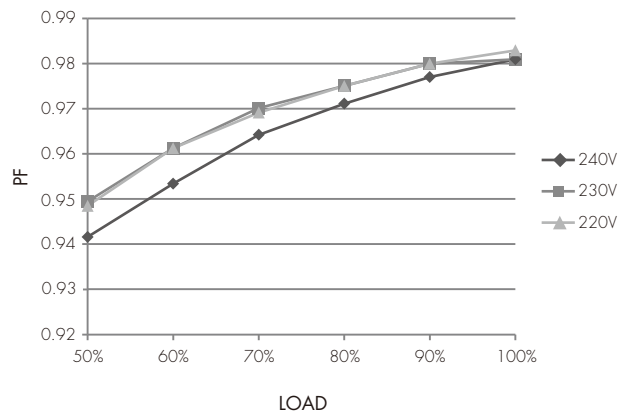

* Typical Power Factor vs Load

HED6060L

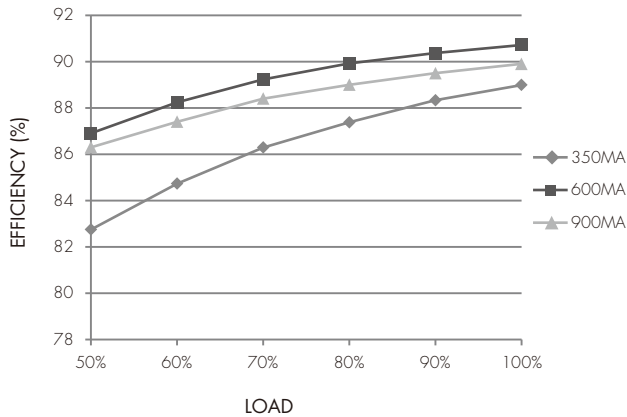

* Typical Efficiency vs Load

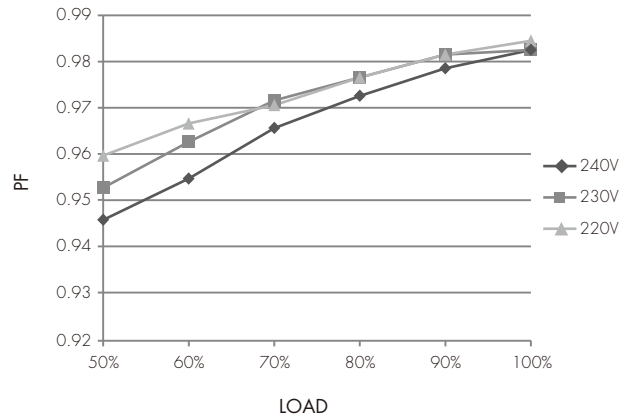

* Typical Power Factor vs Load

Dimming Characteristics

DAI Dimming Curve

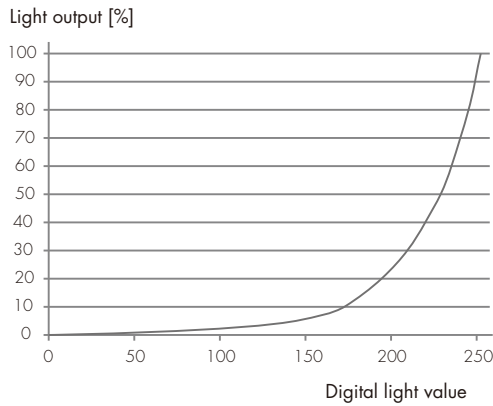

Switch-Dim Dimming Curve

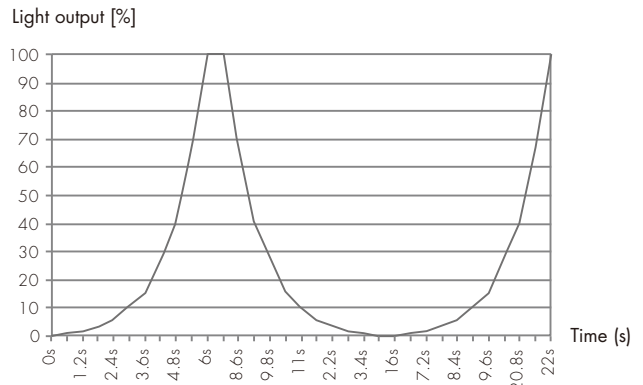

1-10V Dimming Curve

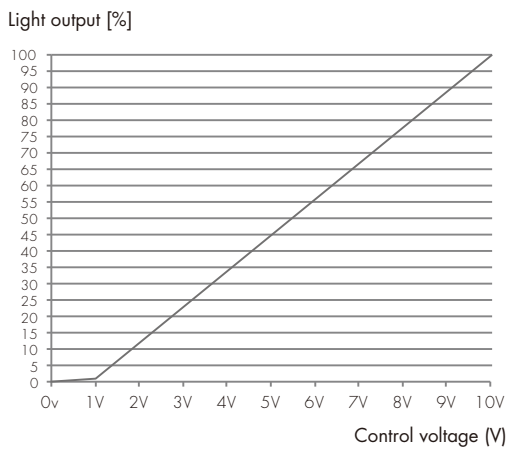

Dimming Profile

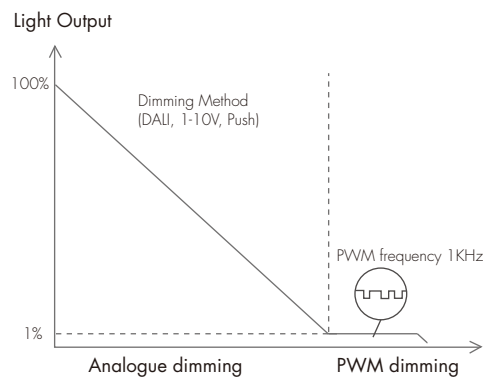

Dimming range	Dimming technique
1%-100%	Analogue
1%	PWM

Dimming Interface Operation Notes

DALI

This series of products are supplied as DALI default group 0 and are 'plug n'play DALI' or 'independent DALI' system ready. These models are also fully DALI addressable and may be assigned to groups within the limits specified by the DALI protocol or supporting DALI controllers by using a DALI programming tool.

Switch-Dim

The provided Switch-Dim interface allows for a simple dimming method using commercially available non-latching (momentary) wall switches. Up to 64 LED drivers may be connected to one switch. The Switch-Dim interface may also be used at the same time as DALI to serve as a manual over-ride.

Switch Action	Response
Short press (<1 second)	Toggle light on / off
Long press (>1 second)	Toggle dim light / increase brightness
Synchronization	
Switch Action	Response
Long press (>1.5 second)	All lights will dim down to minimum then return to 50% brightness

1-10V

The 1-10V input is operable via commercially available simple rotary wall switches designed for 1-10V dimming equipment or from dedicated system central dimming controllers.

Note: In the unlikely event that the LED driver be used with the Switch-Dim or DALI interface prior to using the 1-10V interface, the 1-10V interface may need to be re-set. This is achieved by placing a short circuit across the 1-10V terminals until the light returns to full brightness (approx. 3-5 seconds).